

# KATANA<sup>®</sup>

## CORDLESS LINE TRIMMER INSTRUCTION MANUAL

*18V CHARGE-ALL*

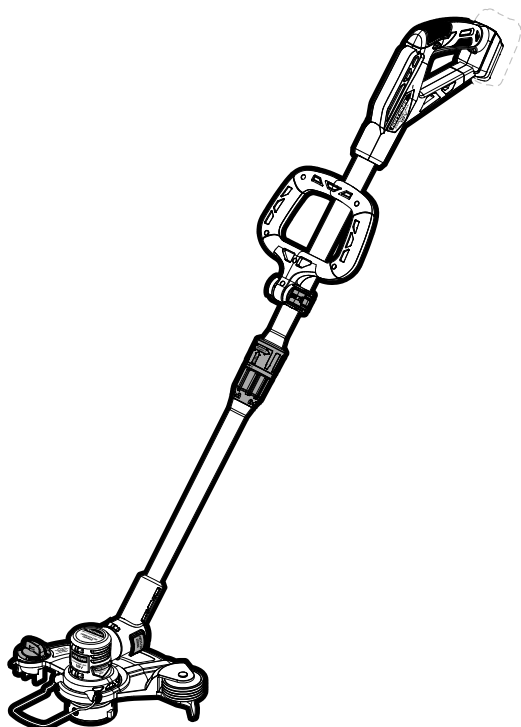

**5 YEAR  
WARRANTY\***

**18V  
LITHIUM ION**

**1.65mm  
LINE THICKNESS**

220210

## GENERAL POWER TOOL SAFETY WARNINGS

220210



**WARNING** Read all safety warnings and all instructions. Failure to follow the warnings and instructions may result in electric shock, fire and/or serious injury. Save all warnings and instructions for future reference. The term "power tool" in the warnings refers to your mains-operated (corded) power tool or battery-operated (cordless) power tool.

## 1) Work area safety

- a) **Keep work area clean and well lit.** Cluttered or dark areas invite accidents.
- b) **Do not operate power tools in explosive atmospheres, such as in the presence of flammable liquids, gases or dust.** Power tools create sparks which may ignite the dust or fumes.
- c) **Keep children and bystanders away while operating a power tool.** Distractions can cause you to lose control.

## 2) Electrical safety

- a) **Power tool plugs must match the outlet. Never modify the plug in any way. Do not use any adapter plugs with earthed (grounded) power tools.** Unmodified plugs and matching outlets will reduce risk of electric shock.
- b) **Avoid body contact with earthed or grounded surfaces, such as pipes, radiators, ranges and refrigerators.** There is an increased risk of electric shock if your body is earthed or grounded.
- c) **Do not expose power tools to rain or wet conditions.** Water entering a power tool will increase the risk of electric shock.
- d) **Do not abuse the cord. Never use the cord for carrying, pulling or unplugging the power tool. Keep cord away from heat, oil, sharp edges or moving parts.** Damaged or entangled cords increase the risk of electric shock.
- e) **When operating a power tool outdoors, use an extension cord suitable for outdoor use.** Use of a cord suitable for outdoor use reduces the risk of electric shock.
- f) **If operating a power tool in a damp location is unavoidable, use a residual current device (RCD) protected supply.** Use of an RCD reduces the risk of electric shock.

## 3) Personal safety

- a) **Stay alert, watch what you are doing and use common sense when operating a power tool. Do not use a power tool while you are tired or under the influence of drugs, alcohol or medication.** A moment of inattention while operating power tools may result in serious personal injury.
- b) **Use personal protective equipment. Always wear eye protection.** Protective equipment such as dust mask, non-skid safety shoes, hard hat, or hearing protection used for appropriate conditions will reduce personal injuries.
- c) **Prevent unintentional starting. Ensure the switch is in the off-position before connecting to power source and/or battery pack, picking up or carrying the tool.** Carrying power tools with your finger on the

switch or energising power tools that have the switch on invites accidents.

- d) **Remove any adjusting key or wrench before turning the power tool on.** A wrench or a key left attached to a rotating part of the power tool may result in personal injury.
- e) **Do not overreach. Keep proper footing and balance at all times.** This enables better control of the power tool in unexpected situations.
- f) **Dress properly. Do not wear loose clothing or jewellery. Keep your hair, clothing and gloves away from moving parts.** Loose clothes, jewellery or long hair can be caught in moving parts.
- g) **If devices are provided for the connection of dust extraction and collection facilities, ensure these are connected and properly used.** Use of dust collection can reduce dust-related hazards.

## 4) Power tool use and care

- a) **Do not force the power tool. Use the correct power tool for your application.** The correct power tool will do the job better and safer at the rate for which it was designed.
- b) **Do not use the power tool if the switch does not turn it on and off.** Any power tool that cannot be controlled with the switch is dangerous and must be repaired.
- c) **Disconnect the plug from the power source and/or the battery pack from the power tool before making any adjustments, changing accessories, or storing power tools.** Such preventive safety measures reduce the risk of starting the power tool accidentally.
- d) **Store idle power tools out of the reach of children and do not allow persons unfamiliar with the power tool or these instructions to operate the power tool.** Power tools are dangerous in the hands of untrained users.
- e) **Maintain power tools. Check for misalignment or binding of moving parts, breakage of parts and any other condition that may affect the power tool's operation. If damaged, have the power tool repaired before use.** Many accidents are caused by poorly maintained power tools.
- f) **Keep cutting tools sharp and clean.** Properly maintained cutting tools with sharp cutting edges are less likely to bind and are easier to control.
- g) **Use the power tool, accessories and tool bits etc. in accordance with these instructions, taking into account the working conditions and the work to be performed.** Use of the power tool for operations different from those intended could result in a hazardous situation.

## 5) Battery tool use and care

- a) **Recharge only with the charger specified by the manufacturer.** A charger that is suitable for one type of battery pack may create a risk of fire when used with another battery pack.
- b) **Use power tools only with specifically designated battery packs.** Use of any other battery packs may create a risk of injury and fire.
- c) **When battery pack is not in use, keep it away from other metal objects, like paper clips, coins, keys,**

nails, screws or other small metal objects, that can make a connection from one terminal to another. Shorting the battery terminals together may cause burns or a fire.

- d) Under abusive conditions, liquid may be ejected from the battery; avoid contact. If contact accidentally occurs, flush with water. If liquid contacts eyes, additionally seek medical help. Liquid ejected from the battery may cause irritation or burns.

### 6) Service

- a) Have your power tool serviced by a qualified repair person using only identical replacement parts. This will ensure that the safety of the power tool is maintained.

### Additional Safety Instructions

- Hold power tool by insulated gripping surfaces, when performing an operation where the cutting accessory may contact hidden wiring. Cutting accessory contacting a "live" wire may make exposed metal parts of the power tool "live" and could give the operator an electric shock.
- This appliance is not intended for use by persons (including children) with reduced physical, sensory or mental capabilities, or lack of experience and knowledge, unless they have been given supervision or instruction concerning use of the appliance by a person responsible for their safety.
- Never allow children or people unfamiliar with these instructions to use the grass trimmer.
- Avoid using the grass trimmer, while people, especially

children or pets, are nearby.

- Use the grass trimmer only in daylight or good artificial light.
- Never operate the grass trimmer with damaged guards or without guards in place.
- Switch on the grass trimmer only when the hands and feet are away from the cutting head.
- Never fit metal cutting blades.
- Use only the manufacturer's recommended replacement parts and accessories.
- Always remove the battery from the grass trimmer when leaving the grass trimmer unattended.
- Always remove the battery from the grass trimmer before carrying out maintenance or cleaning work.
- Inspect and maintain the grass trimmer regularly.** Have the grass trimmer repaired only by an authorized repairer.
- When not in use, store the grass trimmer out of the reach of children.
- Face the cutting head away from yourself, other people and animals while the power is connected to the grass trimmer (especially during operation).
- Remove the battery when changing spools or clearing grass from under the guard.
- Remove the battery from the grass trimmer before making any adjustments.
- Use both handles at all times
- Keep ventilation openings clear of debris. Keep handles dry, clean and free of oil and grease.
- Never reach underneath the grass trimmer (the cutting blade area) until it has completely stopped and the battery has been removed.

## SYMBOLS

The rating plate on your tool may show symbols. These represent important information about the product or instructions on its use.

	Direct current, DC		Waste electrical products should not be disposed of with household waste. Please recycle where facilities exist. Check with your Local Authority or retailer for recycling advice.
	Refer to instruction manual/booklet		
	Wear ear protection		General warning
	Wear eye protection		Regulator compliance mark
	Wear respiratory protection		Do not expose to rain or damp condition.
	Wear foot protection		Do not use metal blade(s) on the product.
	Wear protective gloves		Keep hands away from the cut-off blade.
	Beware of thrown or flying objects. Keep all bystanders, especially children and pets, at least 15m away from the operating area.		

**KNOW YOUR PRODUCT**

**220210**

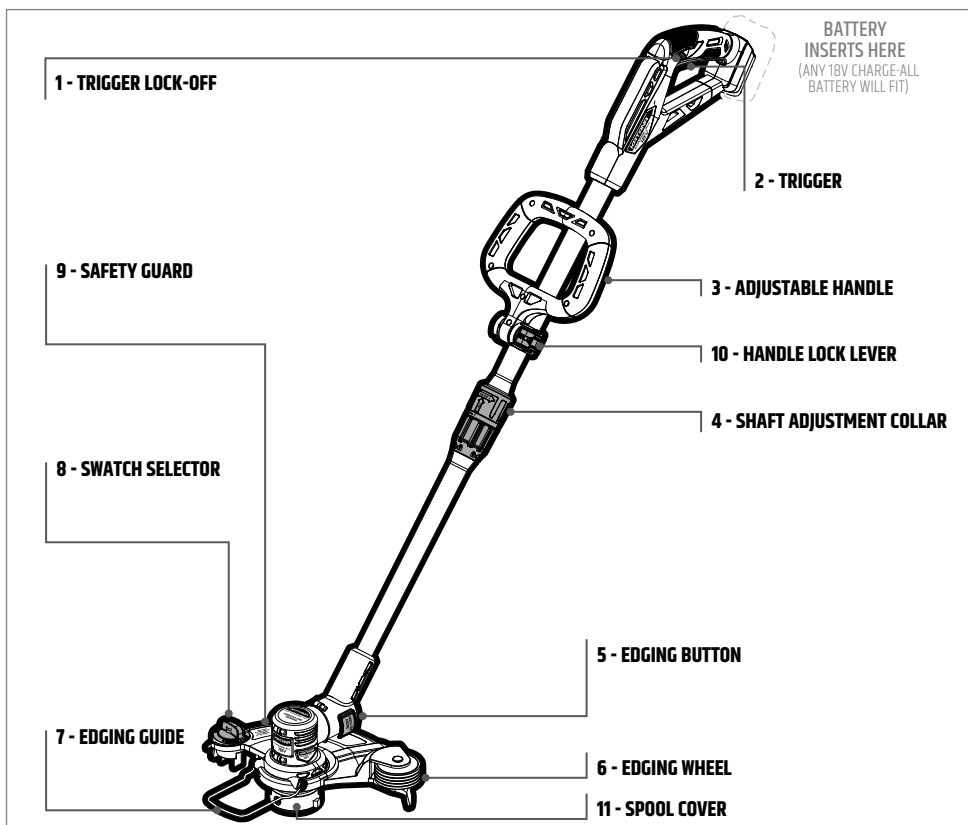

**SPECIFICATIONS**

Voltage	18V d.c.	No load speed	7,200rpm
Cutting Width	250/300 mm	Line Diameter	1.65 mm

**HOW TO INSERT BATTERY ON TOOL**

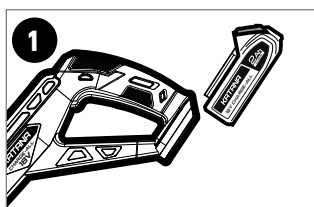

**1. ALIGN BATTERY RIBS WITH TOOL**

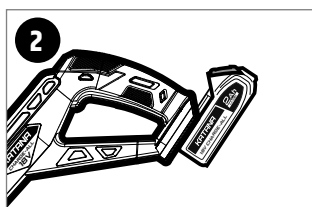

**2. SLIDE INTO TOOL**

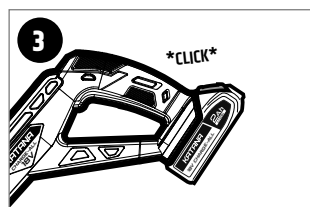

**3. STOP WHEN YOU HEAR IT CLICK IN PLACE**

## LINE TRIMMER BASICS

220210

**WARNING REMOVE BATTERY BEFORE PERFORMING ANY ADJUSTMENTS**

**WARNING!** INSPECT THE AREA TO BE TRIMMED AND REMOVE ANY WIRE, CORD OR STRING-LIKE OBJECTS WHICH COULD BECOME ENTANGLED IN THE ROTATING SPOOL & LINE.

**WARNING!** ALWAYS USE BOTH HANDLES AT ALL TIMES.

**WARNING!** KEEP PROPER FOOTING AND BALANCE AT ALL TIMES AND BE SURE OF PROPER FOOTING ON SLOPES.

**WARNING!** DO NOT OPERATE THE TRIMMER ON A TREE, ON A LADDER, OR ON A SCAFFOLD. THIS IS EXTREMELY DANGEROUS.

**CAUTION!** BYSTANDERS MUST KEEP A MINIMUM SAFE DISTANCE OF 10M AWAY FROM THE TRIMMER WHILE IT IS OPERATING. STONES, PIECES OF METAL AND OTHER OBJECTS CAN BE THROWN OUT AT HIGH SPEED BY THE CUTTING LINE.

**CAUTION!** DO NOT CUT GRASS WHEN WET.

**CAUTION!** DO NOT BUMP THE HEAD ON ANY HARD SURFACES SUCH AS CONCRETE OR BRICK, THIS COULD CAUSE DAMAGE TO THE LINE TRIMMER.

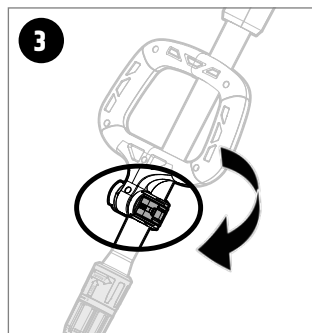
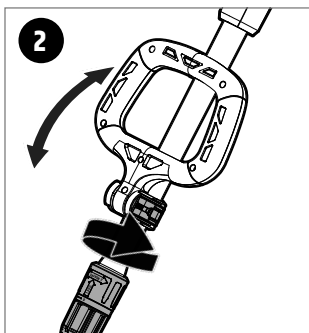
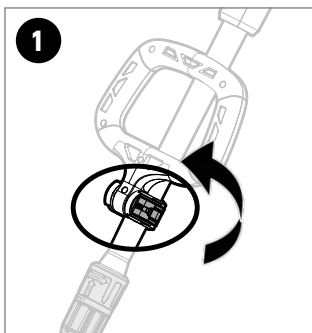
**HOW TO ADJUST HANDLE**

1. Undo handle lock lever (10) to release mechanism.
2. Adjust handle to desired position, the handle tilts, slides and rotates for maximum comfort.
3. Once in the desired position, re-tighten the handle lock lever.

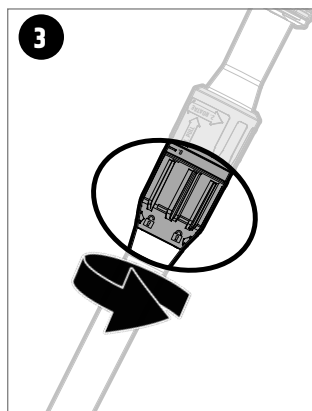
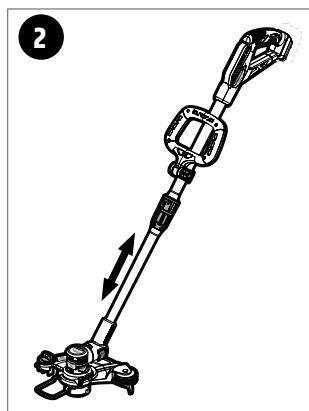
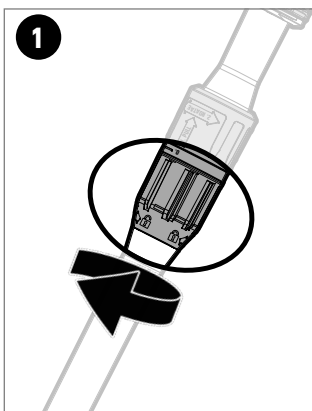
**HOW TO ADJUST SHAFT LENGTH**

1. Rotate the bottom half of the shaft adjustment collar (4) in a clockwise direction (towards the unlock icon) to loosen the shaft.
2. Extend telescopic shaft out to the desired length.
3. Re-tighten bottom half of the shaft adjustment collar in an anti-clockwise direction (towards the lock position) for the unit to be ready for use.

**LINE TRIMMER BASICS**

**220210**

**⚠ WARNING REMOVE BATTERY BEFORE PERFORMING ANY ADJUSTMENTS**

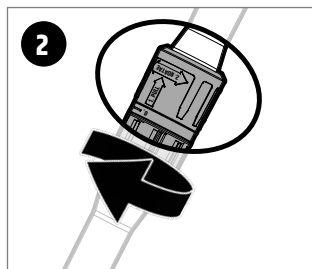
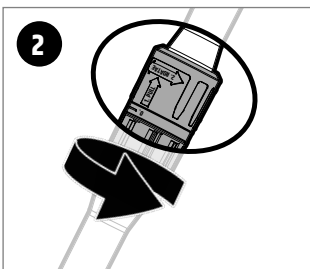
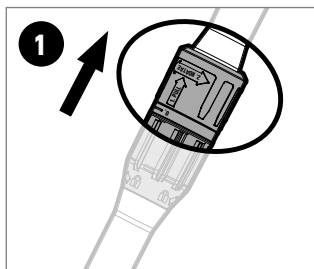

**HOW TO ADJUST SHAFT ROTATION**

1. Pull the top half of the shaft adjustment collar (4) towards the adjustable handle (3) and hold.
2. While holding the top half, rotate the bottom half of the shaft adjustment collar anti-clockwise until it clicks into place. This is now in the 180° position.
3. To rotate the shaft back to the 0° position, do the same but rotate the bottom half of the shaft clockwise.

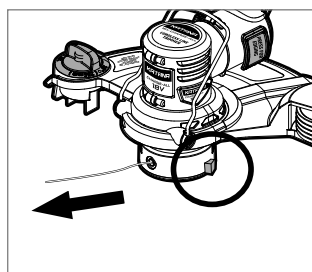
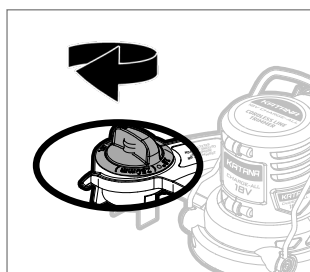
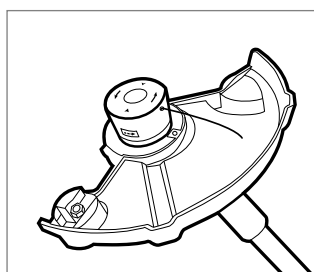

**HOW TO ADJUST LINE LENGTH**

1. The line trimmer has an automatic line feed system which will automatically feed line as you pull the trigger. Each time you pull the trigger, a preset amount of line is fed.
2. You can adjust the length of the cutting line between two options, 30cm and 25cm. To adjust the length, push the swatch selector (3) fully down and rotate it towards the designated length. When rotating, ensure selector is rotated towards the safety guard.
3. If you need to manually lengthen the line, push the button on the side of the spool cover (11) and pull line to desired length. Each push of the button will release a small section of line.

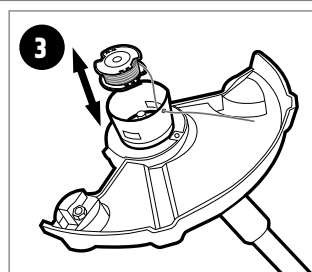
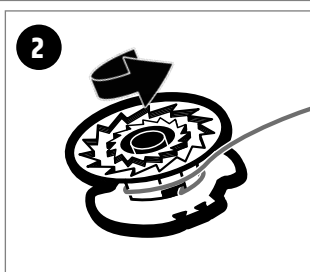
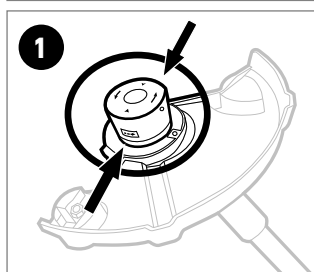

**HOW TO REFILL TRIMMING LINE**

1. Push in the two tabs on the edge of the spool cover and pull to remove the cover revealing the spool.
2. Pull the spool out. Feed the end of the new line into the small slot at the base of the spool. Wind the new line in the direction mentioned on the spool (clockwise if reading the text) ensuring that it is wound as neatly as possible. Ensure the wound line does not exceed the width of the spool.
3. When there is 300mm left of unwound line, re-install the spool and feed the unwound line through the eyelet. Finally, replace the spool cover by pushing it back onto the unit.

**HOW TO USE THE LINE TRIMMER**

**220210**



**WARNING** READ AND UNDERSTAND ALL WARNINGS BEFORE OPERATING THIS TOOL.

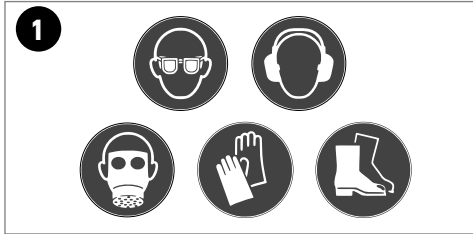

**1. ENSURE SAFETY**

Always wear safety glasses, gloves and boots when working with the line trimmer. Make sure to secure your hair and any baggy clothes. In appropriate situations make sure you wear ear muffs, a mask or a respirator mask.

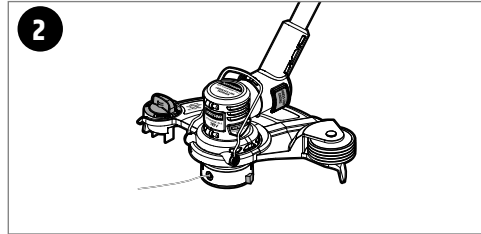

**2. MAKE SURE LINE TRIMMER IS SET UP**

Ensure the line trimmer handle and shaft length are set up to be comfortable for use, the cutting swatch is in the desired position and there is enough line in the spool.

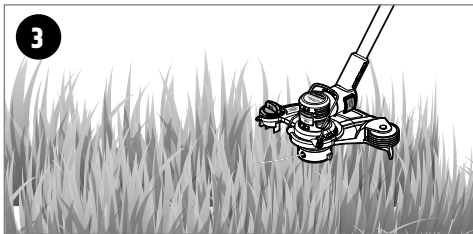

**3. BEGIN TO CUT GRASS**

To use the line trimmer, start with the line away from the cutting area. Pull the trigger (2) and move the trimmer towards the grass you are trying to cut.

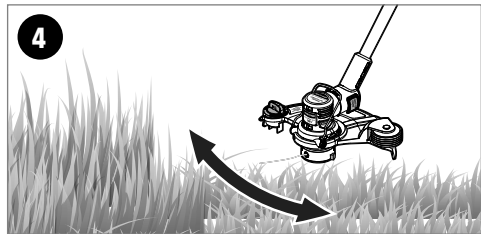

**4. SEVERAL PASSES MAY BE REQUIRED**

Use a sweeping motion side to side to cut the grass. Multiple passes may be required to completely cut the grass.

**HOW TO USE THE LINE TRIMMER FOR EDGING**



**WARNING** READ AND UNDERSTAND ALL WARNINGS BEFORE OPERATING THIS TOOL.

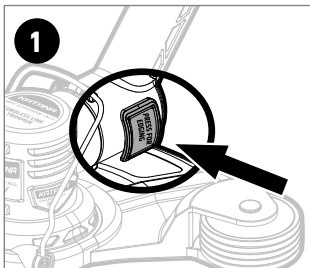

**1. PRESS EDGING BUTTON**

Press the edging button (5), the head of the unit will rotate and the unit is ready for edging.

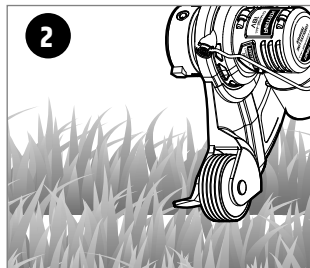

**2. USE EDGING WHEEL OR GUIDE**

Use the edging wheel (6) or edging guide (7) to support the unit as you edge the grass.

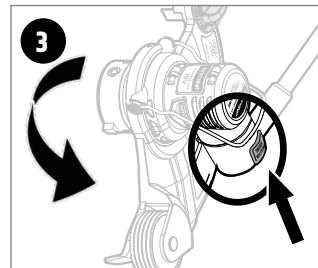

**3. PRESS EDGING BUTTON AND ROTATE**

Press the edging button and manually rotate the head of the unit back to the trimming position.

## MAINTENANCE

220210

This power tool normally requires no maintenance; from time to time the ventilation slots on the motor casing should be cleaned out. If the unit should become defective, repair should be performed by an authorized service agent for electric tools.

Avoid using solvents when cleaning plastic parts. Most plastics are susceptible to damage from various types of commercial solvents and may be damaged by their use. Use clean cloths to remove dirt, dust, oil, grease, etc.

**Warning!**

*Do not at any time let brake fluids, gasoline, petroleum based products, penetrating oils, etc., come in contact with plastic parts. Chemicals can damage, weaken or destroy plastic which may result in serious personal injury.*

# KATANA®

**Australia & Global**

[www.katanapowertools.com.au](http://www.katanapowertools.com.au)

[enquiries@katanapowertools.com.au](mailto:enquiries@katanapowertools.com.au)

+61 3 9730 7100

Made to Katana specifications and quality standards in China.

NOT INTENDED FOR TRADE USE



\* Standard 3 year warranty with an additional 2 year warranty available subject to online registration via [katanapowertools.com.au](http://katanapowertools.com.au). Warranty on this Katana product is given by Kinchrome Australia Pty Ltd of 3 Lakeview Drive, Caribbean Park, Scoresby, Victoria, Australia (Tel +61 3 9730 7100) If this product has materials or workmanship defects (other than defects caused by abnormal or non warranted use) you can, at your cost, send the product to place of purchase, an authorised Kinchrome service agent or one of Kinchromes addresses for repair or replacement.

Your rights under this warranty are in addition to any other rights you have under the Australian Consumer Law or other applicable laws. Our goods come with guarantees that cannot be excluded under the Australian Consumer Law. You are entitled to a replacement or refund for a major failure and compensation for any other reasonably foreseeable loss or damage. You are also entitled to have the goods repaired or replaced if the goods fail to be of acceptable quality and the failure does not amount to a major failure. For further details please visit [www.kinchrome.com.au](http://www.kinchrome.com.au) or call us. Due to minor changes in design or manufacture, the product you purchase may sometimes differ from the one shown on the packaging.