

KATANA®

CORDLESS CIRCULAR SAW INSTRUCTION MANUAL

18V CHARGE-ALL

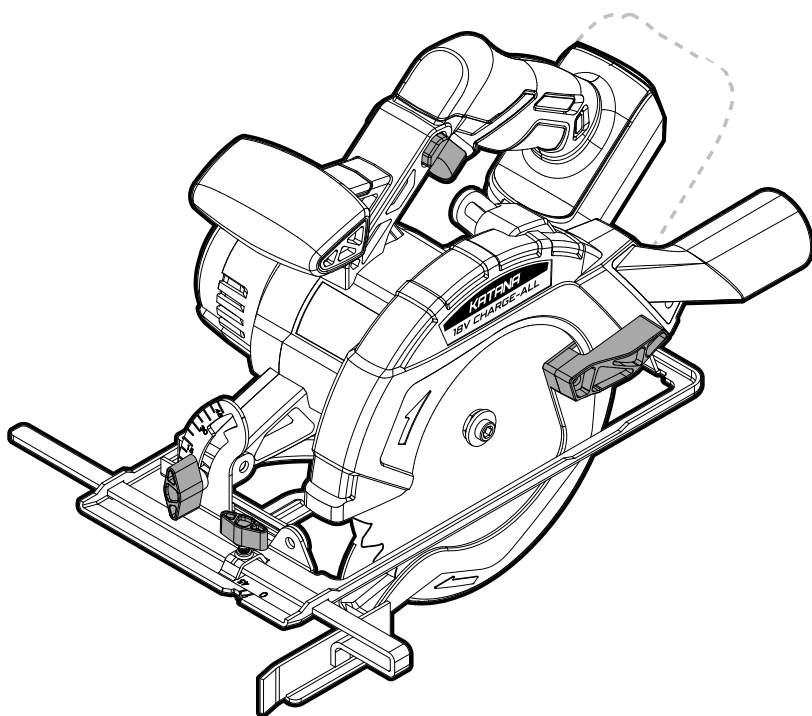

**5 YEAR
WARRANTY***

**18V
LITHIUM ION**

**165mm
BLADES**

220080

GENERAL POWER TOOL SAFETY WARNINGS

220080



WARNING Read all safety warnings and all instructions. Failure to follow the warnings and instructions may result in electric shock, fire and/or serious injury. Save all warnings and instructions for future reference. The term "power tool" in the warnings refers to your mains-operated (corded) power tool or battery-operated (cordless) power tool.

1) Work area safety

- a) Keep work area clean and well lit. Cluttered or dark areas invite accidents.
- b) Do not operate power tools in explosive atmospheres, such as in the presence of flammable liquids, gases or dust. Power tools create sparks which may ignite the dust or fumes.
- c) Keep children and bystanders away while operating a power tool. Distractions can cause you to lose control.

2) Electrical safety

- a) Power tool plugs must match the outlet. Never modify the plug in any way. Do not use any adapter plugs with earthed (grounded) power tools. Unmodified plugs and matching outlets will reduce risk of electric shock.
- b) Avoid body contact with earthed or grounded surfaces, such as pipes, radiators, ranges and refrigerators. There is an increased risk of electric shock if your body is earthed or grounded.
- c) Do not expose power tools to rain or wet conditions. Water entering a power tool will increase the risk of electric shock.
- d) Do not abuse the cord. Never use the cord for carrying, pulling or unplugging the power tool. Keep cord away from heat, oil, sharp edges or moving parts. Damaged or entangled cords increase the risk of electric shock.
- e) When operating a power tool outdoors, use an extension cord suitable for outdoor use. Use of a cord suitable for outdoor use reduces the risk of electric shock.
- f) If operating a power tool in a damp location is unavoidable, use a residual current device (RCD) protected supply. Use of an RCD reduces the risk of electric shock.

3) Personal safety

- a) Stay alert, watch what you are doing and use common sense when operating a power tool. Do not use a power tool while you are tired or under the influence of drugs, alcohol or medication. A moment of inattention while operating power tools may result in serious personal injury.
- b) Use personal protective equipment. Always wear eye protection. Protective equipment such as dust mask, non-skid safety shoes, hard hat, or hearing protection used for appropriate conditions will reduce personal injuries.
- c) Prevent unintentional starting. Ensure the switch is in the off-position before connecting to power source and/or battery pack, picking up or carrying the tool. Carrying power tools with your finger on the switch or energising power tools that have the switch on invites accidents.
- d) Remove any adjusting key or wrench before turning the power tool on. A wrench or a key left attached to a rotating part of the power tool may result in personal injury.
- e) Do not overreach. Keep proper footing and balance at all times. This enables better control of the power tool in unexpected situations.
- f) Dress properly. Do not wear loose clothing or jewellery. Keep your hair, clothing and gloves away from moving parts. Loose clothes, jewellery or long hair can be caught in moving parts.
- g) If devices are provided for the connection of dust extraction and collection facilities, ensure these are connected and properly used. Use of dust collection can reduce dust-related hazards.

4) Power tool use and care

- a) Do not force the power tool. Use the correct power tool for your application. The correct power tool will do the job better and safer at the rate for which it was designed.
- b) Do not use the power tool if the switch does not turn it on and off. Any power tool that cannot be controlled with the switch is dangerous and must be repaired.
- c) Disconnect the plug from the power source and/or the battery pack from the power tool before making any adjustments, changing accessories, or storing power

tools. Such preventive safety measures reduce the risk of starting the power tool accidentally.

- d) Store idle power tools out of the reach of children and do not allow persons unfamiliar with the power tool or these instructions to operate the power tool. Power tools are dangerous in the hands of untrained users.
 - e) Maintain power tools. Check for misalignment or binding of moving parts, breakage of parts and any other condition that may affect the power tool's operation. If damaged, have the power tool repaired before use. Many accidents are caused by poorly maintained power tools.
 - f) Keep cutting tools sharp and clean. Properly maintained cutting tools with sharp cutting edges are less likely to bind and are easier to control.
 - g) Use the power tool, accessories and tool bits etc. in accordance with these instructions, taking into account the working conditions and the work to be performed. Use of the power tool for operations different from those intended could result in a hazardous situation.
- 5) Battery tool use and care
- a) Recharge only with the charger specified by the manufacturer. A charger that is suitable for one type of battery pack may create a risk of fire when used with another battery pack.
 - b) Use power tools only with specifically designated battery packs. Use of any other battery packs may create a risk of injury and fire.
 - c) When battery pack is not in use, keep it away from other metal objects, like paper clips, coins, keys, nails, screws or other small metal objects, that can make a connection from one terminal to another. Shorting the battery terminals together may cause burns or a fire.
 - d) Under abusive conditions, liquid may be ejected from the battery; avoid contact. If contact accidentally occurs, flush with water. If liquid contacts eyes, additionally seek medical help. Liquid ejected from the battery may cause irritation or burns.
- 6) Service
- a) Have your power tool serviced by a qualified repair person using only identical replacement parts. This will ensure that the safety of the power tool is maintained.

Additional Safety Instruction Circular Saw

- a) Keep hands away from cutting area and the blade. Keep your second hand on auxiliary handle, or motor housing. If both hands are holding the saw, they cannot be cut by the blade.
- b) Do not reach underneath the workpiece. The guard cannot protect you from the blade below the workpiece.
- c) Adjust the cutting depth to the thickness of the workpiece. Less than a full tooth of the blade teeth should be visible below the workpiece.
- d) Never hold piece being cut in your hands or across your leg. Secure the workpiece to a stable platform. It is important to support the work properly to minimize body exposure, blade binding, or loss of control.
- e) Hold power tool by insulated gripping surfaces when performing an operation where the cutting tool may contact hidden wiring. Contact with a "live" wire will also make exposed metal parts of the power tool "live" and shock the operator.
- f) When ripping always use a rip fence or straight edge guide. This improves the accuracy of cut and reduces the chance of blade binding.
- g) Always use blades with correct size and shape (diamond versus round) of arbour holes. Blades that do not match the mounting hardware of the saw will run eccentrically, causing loss of control.

h) **Never use damaged or incorrect blade washers or bolt.** The blade washers and bolt were specially designed for your saw, for optimum performance and safety of operation.

Further safety instructions for all saws

Causes and operator prevention of kickback:

- Kickback is a sudden reaction to a pinched, bound or misaligned saw blade, causing an uncontrolled saw to lift up and out of the workpiece toward the operator;
- When the blade is pinched or bound tightly by the kerf closing down, the blade stalls and the motor reaction drives the unit rapidly back toward the operator;
- If the blade becomes twisted or misaligned in the cut, the teeth at the back edge of the blade can dig into the top surface of the wood causing the blade to climb out of the kerf and jump back toward the operator.
- Kickback is the result of saw misuse and/or incorrect operating procedures or conditions and can be avoided by taking proper precautions as given below.









- a) **Maintain a firm grip with both hands on the saw and position your arms to resist kickback forces. Position your body to either side of the blade, but not in line with the blade.** Kickback could cause the saw to jump backwards, but kickback forces can be controlled by the operator, if proper precautions are taken.
- b) **When blade is binding, or when interrupting a cut for any reason, release the trigger and hold the saw motionless in the material until the blade comes to a complete stop.** Never attempt to remove the saw from the work or pull the saw backward while the blade is in motion or kickback may occur. Investigate and take corrective actions to eliminate the cause of blade binding.
- c) **When restarting a saw in the workpiece, centre the saw blade in the kerf and check that saw teeth are not engaged into the material.** If saw blade is binding, it may walk up or kickback from the workpiece as the saw is restarted.
- d) **Support large panels to minimise the risk of blade pinching and kickback.** Large panels tend to sag under their own weight. Supports must be placed under the panel on both sides, near the line of cut and near the edge of the panel.
- e) **Do not use dull or damaged blades.** Blunt or improperly set blades produce narrow kerf causing excessive friction, blade

binding and kickback.

- f) **Blade depth and bevel adjusting locking levers must be tight and secure before making cut.** If blade adjustment shifts while cutting, it may cause binding and kickback.
- g) **Use extra caution when making a "plunge cut" into existing walls or other blind areas.** The protruding blade may cut objects that can cause kickback.
- h) **Check lower guard for proper closing before each use. Do not operate the saw if lower guard does not move freely and close instantly. Never clamp or tie the lower guard into the open position.** If saw is accidentally dropped, lower guard may be bent. Raise the lower guard with the retracting handle and make sure it moves freely and does not touch the blade or any other part, in all angles and depths of cut.
- i) **Check the operation of the lower guard spring. If the guard and the spring are not operating properly, they must be serviced before use.** The lower guard may become sluggish due to, gummy deposits, or a build-up of debris.
- j) **Lower guard may be retracted manually only for special cuts such as "plunge cuts" and "compound cuts."** Raise lower guard by retracting handle and as soon as blade enters the material, the lower guard must be released. For all other sawing, the lower guard should operate automatically.
- k) **Always observe that the lower guard is covering the blade before placing saw down on bench or floor.** An unprotected, coasting blade will cause the saw to walk backwards, cutting whatever is in its path. Be aware of the time it takes for the blade to stop after switch is released.
- l) **This appliance is not intended for use by persons (including children) with reduced physical, sensory or mental capabilities, or lack of experience and knowledge, unless they have been given supervision or instruction concerning use of the appliance by a person responsible for their safety.**
- m) **Never hold piece being cut in your hands or across your leg. Secure the workpiece to a stable platform.** It is important to support the work properly to minimize body exposure, blade binding, or loss of control.
- n) **Do not use the tool with abrasive or masonry/wet diamond wheels.**
- o) **Only use blade diameter(s) in accordance with the markings on the tool.**

SYMBOLS

The rating plate on your tool may show symbols. These represent important information about the product or instructions on its use.

	Direct current, DC		Waste electrical products should not be disposed of with household waste. Please recycle where facilities exist. Check with your Local Authority or retailer for recycling advice.
	Refer to instruction manual/booklet		General warning
	Wear ear protection		Regulator compliance mark
	Wear eye protection		
	Wear respiratory protection		

KNOW YOUR PRODUCT

220080

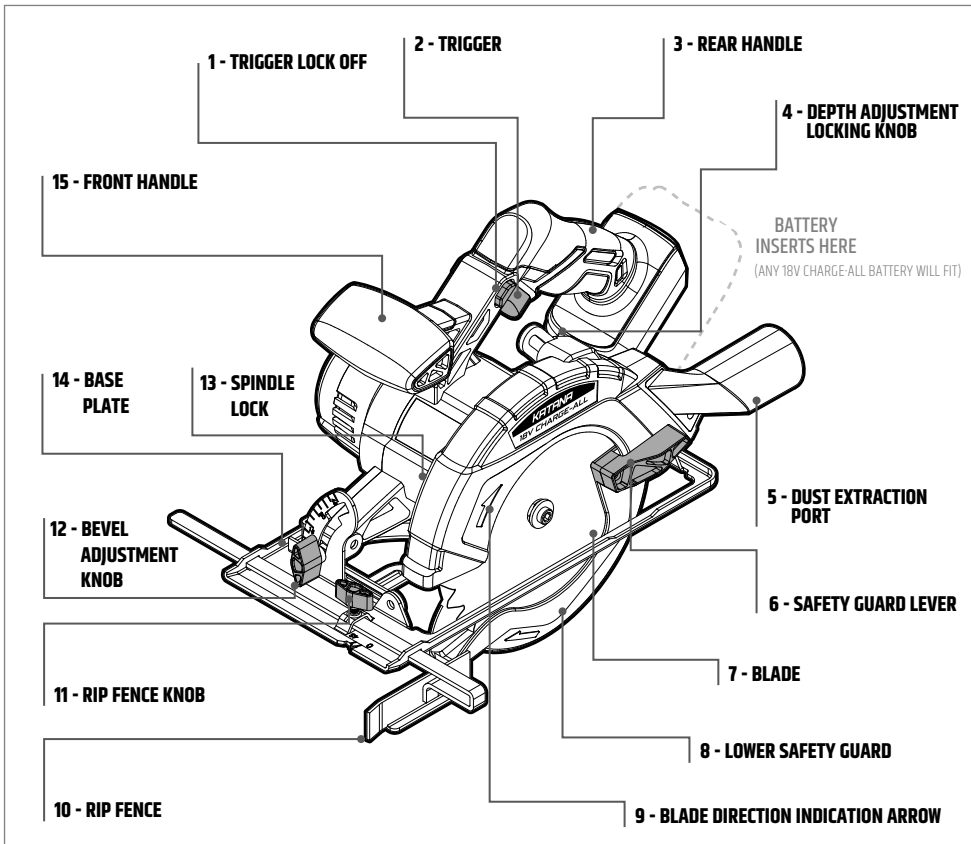

SPECIFICATIONS

Voltage	18V d.c.	Max. Cut at 90°	54mm
Blade Size	165mm	Max. Cut at 45°	40mm
Blade bore Size	16mm	No Load Speed	3800 rpm

HOW TO INSERT BATTERY ON TOOL

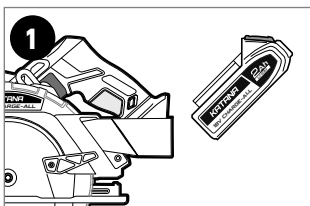

1. ALIGN BATTERY RIBS WITH TOOL

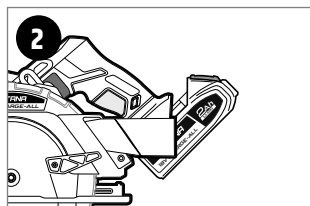

2. SLIDE INTO TOOL

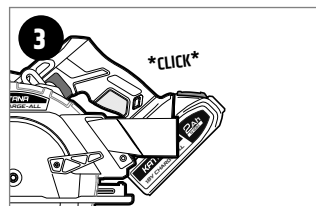

3. STOP WHEN YOU HEAR IT CLICK IN PLACE

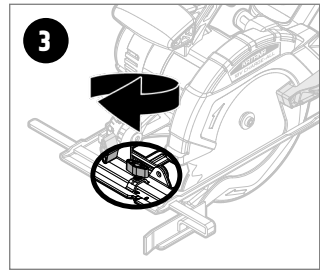
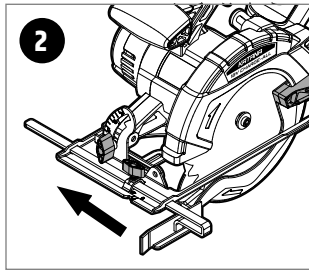
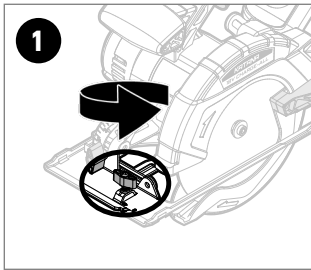
CIRCULAR SAW BASICS**220080****HOW TO ATTACH THE RIP FENCE**

1. Loosen rip fence knob (11)
2. Slide the rip fence (10) through the slots with the guide plate facing down
3. When at the desired width, tighten the rip fence knob

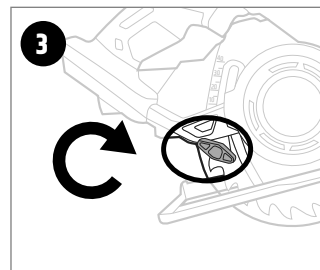
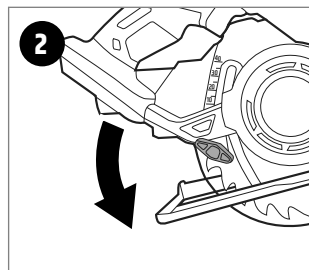
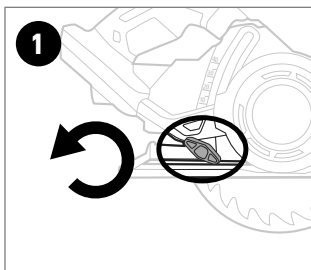
**HOW TO ADJUST BLADE DEPTH**

1. Loosen the depth adjustment locking knob (4)
2. Adjust the saw to the desired depth
3. Once at the desired depth, tighten the depth adjustment knob

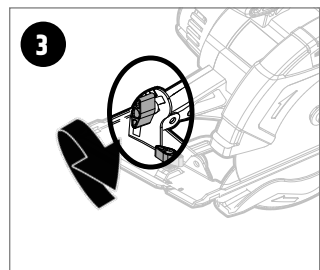
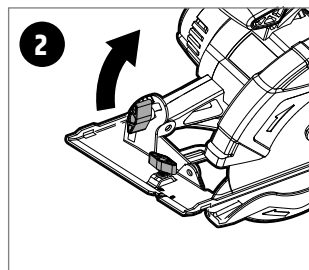
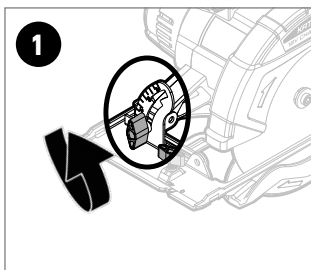
**HOW TO ADJUST SAW BEVEL**

1. Loosen the bevel adjustment knob (12)
2. Tilt the base plate (14) to the desired bevel
3. Once at the desired bevel, tighten the bevel adjustment knob

HOW TO FIT/REPLACE BLADE

220080

**WARNING**

- REMOVE BATTERY BEFORE REMOVING OR INSERTING BLADES
- THE MAX RATING OF THE SAW BLADE MUST BE HIGHER THAN 3800 RPM

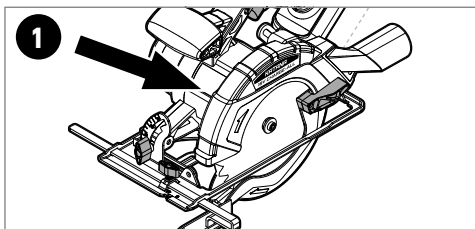

1. Press & hold spindle lock (13)

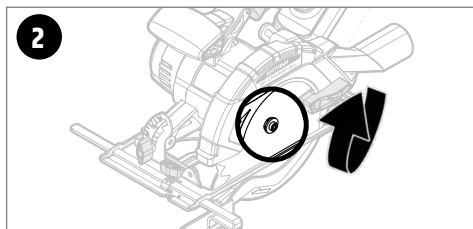

2. Remove spindle bolt with provided hex key (under front handle in saw body). The thread is left hand thread, turn the bolt clockwise to loosen.

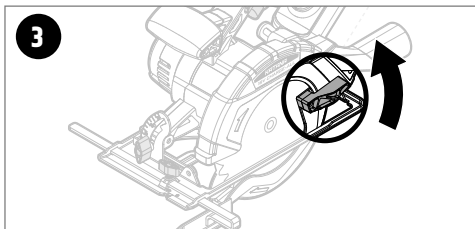

3. Pull up the safety guard lever (6) to move the lower safety guard (8) to allow space for the blade to be removed.

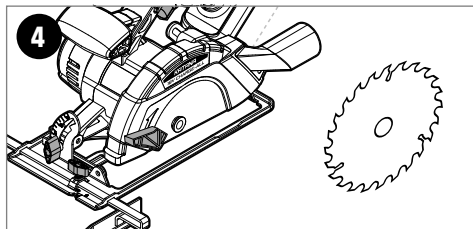

4. Remove the old blade and while still holding the safety guard lever.

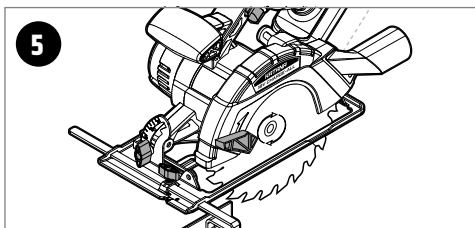

5. Insert the new blade ensuring the direction arrows on the blade match the blade direction indication arrow (9).

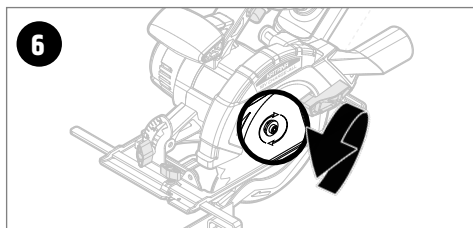

6. To refit the spindle bolt and flange, hold the spindle lock and tighten the bolt by turning it anti-clockwise. Ensure it is fastened securely and the blade is seated correctly.

HOW TO MAKE A CUT

220080

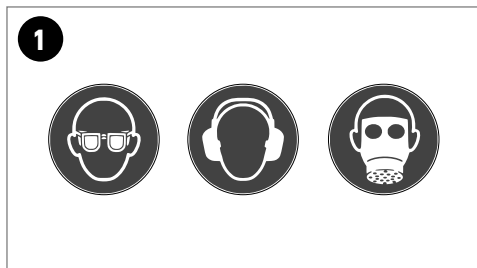

1. ENSURE SAFETY

Always wear safety glasses when working with the circular saw. Make sure to secure your hair and any baggy clothes. In appropriate situations make sure you wear ear muffs, a mask or a respiratory mask.

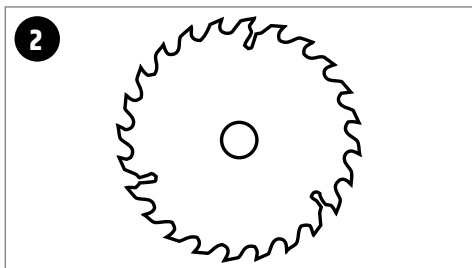

2. MAKE SURE YOU HAVE THE RIGHT BLADE

Ensure you have the correct rated blade for the job. The blade supplied is for cutting wood. Check blade instructions for the uses of different blades.

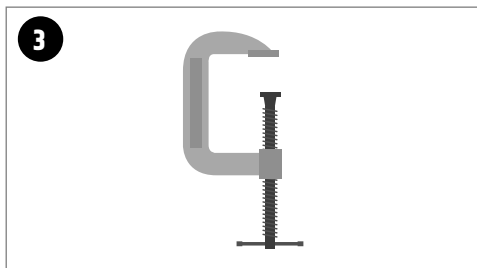

3. SECURE WORKPIECE

Make sure your workpiece is securely fastened.

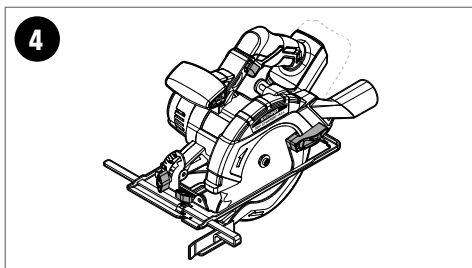

4. ENSURE SAW IS SET UP CORRECTLY

Ensure that the saw depth, bevel and rip fence (if attached) are set up correctly and the safety guards are in their correct position.

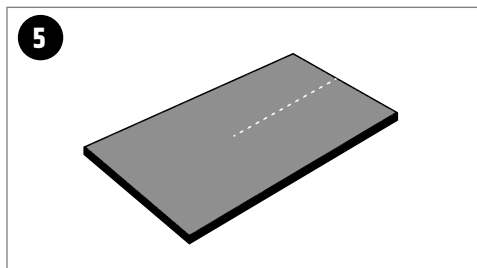

5. MEASURE TWICE, CUT ONCE

Have your job planned and marked out.

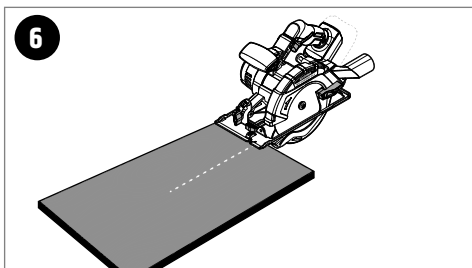

6. CUT YOUR WORKPIECE

Put the front of the saw's baseplate on your workpiece whilst ensuring the blade isn't touching the material. Hold the saw securely. Push the trigger lock off (1) and pull the trigger (2), then slowly move the blade towards where you are intending to cut. Guide the circular saw along the marked line while letting the saw do the work.

MAINTENANCE

220080

This power tool normally requires no maintenance; from time to time the ventilation slots on the motor casing should be cleaned out. If the unit should become defective, repair should be performed by an authorized service agent for electric tools.

Avoid using solvents when cleaning plastic parts. Most plastics are susceptible to damage from various types of commercial solvents and may be damaged by their use. Use clean cloths to remove dirt, dust, oil, grease, etc.

Warning!

Do not at any time let brake fluids, gasoline, petroleum based products, penetrating oils, etc., come in contact with plastic parts. Chemicals can damage, weaken or destroy plastic which may result in serious personal injury.

KATANA®

Australia & Global

www.katanapowertools.com.au

enquiries@katanapowertools.com.au

+61 3 9730 7100

Made to Katana specifications and quality standards in China.

NOT INTENDED FOR TRADE USE

5 YEAR WARRANTY*

* Standard 3 year warranty with an additional 2 year warranty available subject to online registration via katanapowertools.com.au. Warranty on this Katana product is given by Kincrome Australia Pty Ltd of 3 Lakeview Drive, Caribbean Park, Scoresby, Victoria, Australia (Tel +61 3 9730 7100) If this product has materials or workmanship defects (other than defects caused by abnormal or non warranted use) you can, at your cost, send the product to place of purchase, an authorised Kincrome service agent or one of Kincromes addresses for repair or replacement.

Your rights under this warranty are in addition to any other rights you have under the Australian Consumer Law or other applicable laws. Our goods come with guarantees that cannot be excluded under the Australian Consumer Law. You are entitled to a replacement or refund for a major failure and compensation for any other reasonably foreseeable loss or damage. You are also entitled to have the goods repaired or replaced if the goods fail to be of acceptable quality and the failure does not amount to a major failure. For further details please visit www.kincrome.com.au or call us. Due to minor changes in design or manufacture, the product you purchase may sometimes differ from the one shown on the packaging.